

RideSense User Manual

RideSense overview:

Giant RideSense employs ANT+ and Bluetooth® Smart (BLE 4.0) license certification technology.

ANT+: ANT+ certification compliant meter.

Bluetooth® Smart (BLE 4.0): Bluetooth® Smart (BLE 4.0) compliant system App.

Accessories included **A**

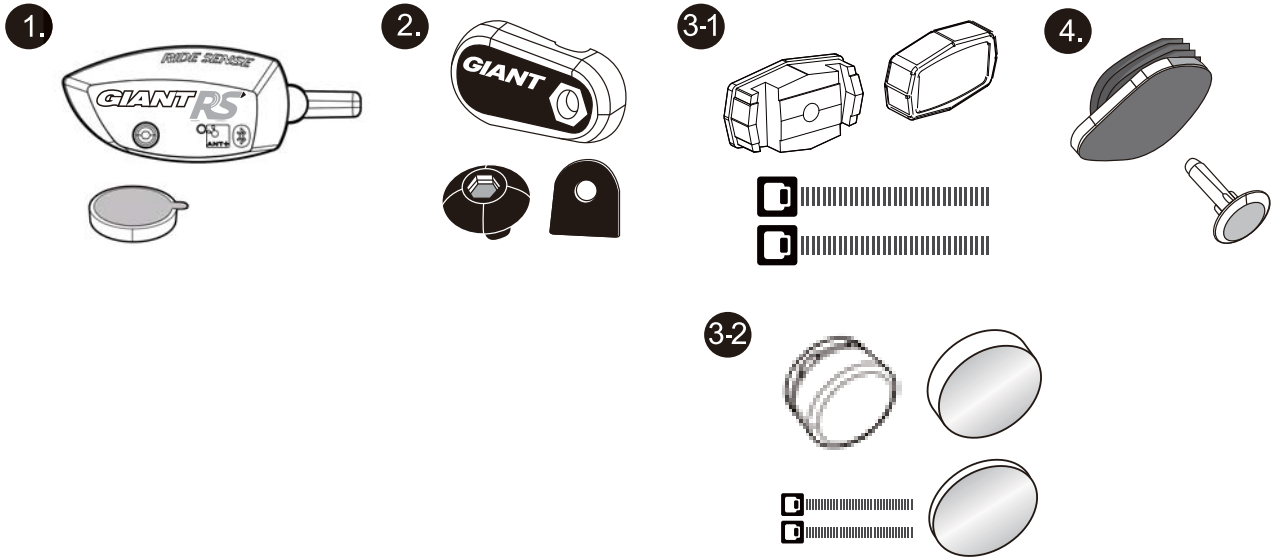

- 1. RideSense x1: Hexagon socket head cap screw (SHCS) x1, (for 2.5mm hex wrench with the maximum locking torque of 0.4Nm); washer x1; CR2032 battery x1
- 2. Speed sensor magnet x1: round head SHCS x1 (for 3mm hex wrench with the maximum locking torque of 0.5Nm); washer x1
- 3. Cadence sensor magnet x1: ties x2; washer x1(3-1) or x2(3-2)
- 4. Chain stay plug—included with your bike (not included with standalone RideSense product)

▲ Note: Please check accessories included with your RideSense product before installation. In case of any damage or shortage, call the dealer from whom you purchased your RideSense product or Giant immediately. For a RideSense product that came with your new bike, remember to get the magnet set and chain stay plug from the dealer who sold you the bike.

Product specification

Specification	Information	Description
Wireless technology	ANT+ Bluetooth® Smart (BLE 4.0)	RideSense is a signal transmission device. See Meter and App manual for details on pairing operation.
Battery	CR2032 battery x1	Please remove the battery from your product if it will not be used for a long period of time. This will prevent sensor damage by leaking of battery electrolyte.
Time to last (estimate)	May last around 500 hours for continuous use	The battery may last one and half a years when used approximately one hour per day.
Sensor range	1. ANT+: 10 meters in open space 2. Bluetooth®: 40 meters in open space	Effective sensor range varies with actual environment conditions.

Water and dirt proof grade	IP X7	
Weight	18 grams	Includes one CR2032 battery
LED light indicators	Green and red light each	Green light: speed Red light: cadence
Operating temperature range	-20°C - 60°C	
Speed/Cadence App supported OS versions	Android 4.3 or later; iOS 7 or later	See individual App installation manual for list of compatible models.

Function mode

Function	Description	Remark
ANT+ pairing	Connecting to meter ANT+	To enable the meter's pairing mode and search for RideSense device, please refer to the meter user manual.
Bluetooth pairing	Connecting to App	To enable the App's pairing mode and search for RideSense device, please refer to the App user manual.
Power saving and sleep	The RideSense goes into sleep mode without sensing any magnet motion in 20 minutes.	The system auto wakes up and is connected once a cadence or speed magnet motion is detected in sleep mode. The device remains active (instead of entering the power saving and sleep mode) in alarm mode.
Power saving, sleep and wakeup	The RideSense wakes up once the cadence magnet or speed magnet motion has been detected	The RideSense device is started and the connection resumed once cadence magnet or speed magnet motion is detected by RideSense.
Reset	Reset the device	Press and hold the RESET button for 12 seconds and wait for the red and green indicator to light up once respectively.
Low battery reminder	The alarm function starts and the red LED light flashes three times when power of the battery gets low. Replace the battery immediately.	Replace the battery immediately.

Installation steps

To install the battery cover: **B**

▲ Warning: Make sure edge of the battery cover is well placed before installing your RideSense. Otherwise, the battery cover may fail to seal properly, the battery compartment spring may fail, or the waterproof function may fail. (Please refer to installation steps provided earlier.)

1.



2.



3.



4.



5.

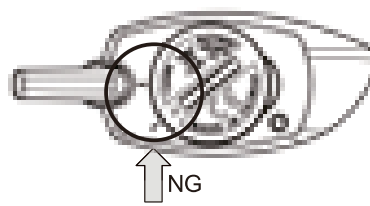
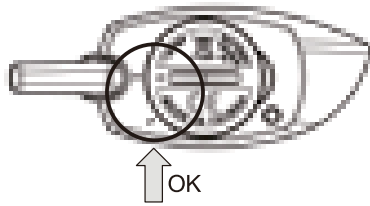

To install RideSense: **C**

Remove the bike included chain stay plug (not included with standalone RideSense units), insert the RideSense cadence stick into the chain stay tube, attach and fasten the RideSense device to the chain stay with one SHCS using a 2.5mm hex wrench at maximum locking torque of 0.4Nm.

▲ Note: Please make sure the battery cover is seated correctly for 100% waterproof protection.

▲ Warning: Check and make sure the RideSense unit is secure before each ride to ensure proper function and reduce the risk of potential severe personal injury.

1.

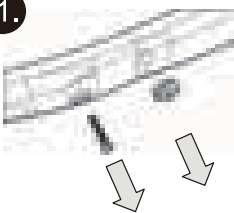

2.

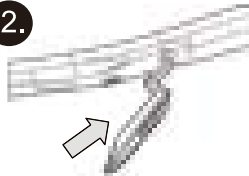

3.

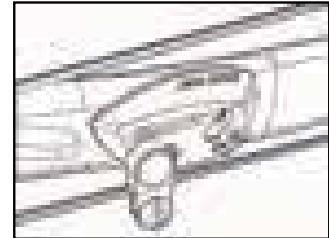
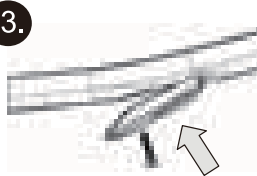

Installing the cadence sensor magnet: **D**

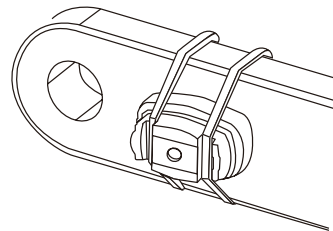
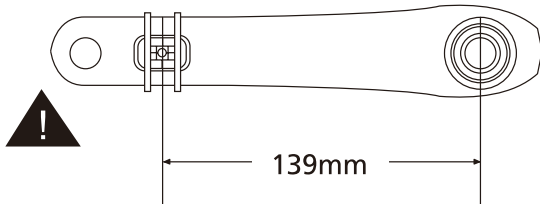

▲ Note: Please fasten the cadence sensor magnet to the crank with the included tie. Tear off the tape at back of the cadence sensor magnet, attach and fix it at inside of the left crank 139mm (±6mm) away from center of the bottom bracket with the included cable ties, rotate the crank to test the cadence sensor magnet.

▲ Note: Raise the cadence sensor magnet with included pad to keep it within 7mm(3-1) / 12mm(3-2) from the frame or motion of the cadence sensor magnet may fail to be detected.

Installation the speed sensor magnet: **E&F**

▲ Note: Keep the speed sensor magnet and RideSense 2~10mm away from each other. You may flip the speed sensor magnet and install it to the rear wheel spoke ensuring the proper gap between the two interfaces.

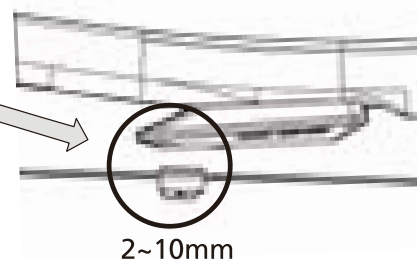
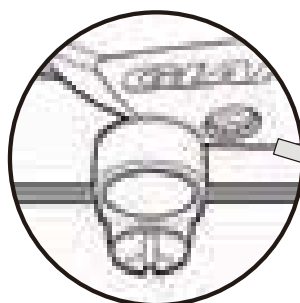
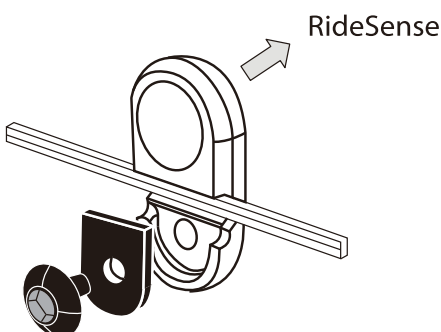

In case the speed sensor magnet is too close to or interfering with the RideSense, install them at location away from each other (ensure end of the device 2~3mm away from the edge of speed sensor magnet). Otherwise, the speed sensor magnet may hit the RideSense and result in damage. See figure below for correct installation position.

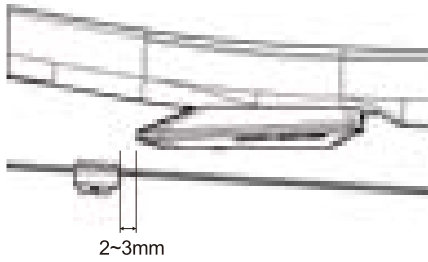

■ Ensure end of the device 2~3mm away from the edge of speed sensor magnet.

Remove RideSense:

Remove the screw, push the device forward, compress and deform the silica gel before pulling it upward, remove it carefully without damaging the cadence stick. Insert the chain stay plug in the fix opening for RideSense after it was removed.

⚠Warning: Pulling RideSense vertically upward from its installation location may damage the RideSense unit or the frame and breach your warranty terms.

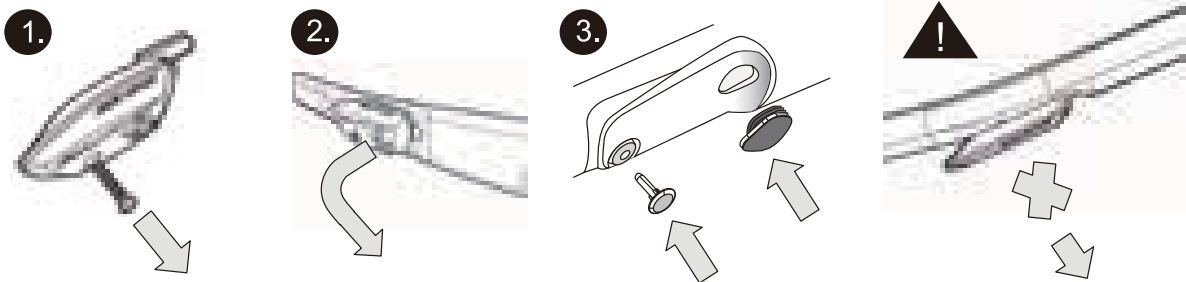

RideSense maintenance

① Replace battery

⚠Note: Check remaining power of your battery before riding your bike ride. Low battery may lead to RideSense sensor error or pairing failure.

⚠Note: Wait 30 seconds for the RideSense unit to reset after its battery was removed to ensure successful operation after battery replacement.

⚠Note: Remove the battery from the RideSense unit if it will not be used for long periods of time. This will prevent the sensor from damage by leaking of battery electrolyte.

⚠Warning: Insert a battery in the battery compartment before locking the battery cover with the screw. Make sure edge of the battery cover is secure or the battery cover may fail to seal properly, the battery compartment spring may fail, or the waterproof function may fail. (Please refer to installation steps provided earlier.)

Reset RideSense

Method 1: Remove the battery, wait 30 seconds before inserting it back into the unit. RideSense is now reset.

Method 2: Press and hold the RESET button for 12 seconds and wait for the red and green indicator to light up once respectively. RideSense is now reset.

Notes:

- ① The sensor may be used on rainy days but do not submerge under water. DO NOT clean RideSense with a high-pressure water jet.
- ② Please check distance between the sensor and its sensor magnets regularly.
- ③ DO NOT clean the sensor with chemical cleaners.
- ④ Be mindful of your cycling safety.



Warranty statement

- ① Giant shall warrant your RideSense for a period of 2 years after its date of purchase. During this warranty period a Giant authorized dealer shall offer comprehensive after service for damages under normal operation according to the user manual and determined to be caused by product defects or quality.
- ② If the problem of your product persists after taking troubleshooting measures provided in the user manual, please present your purchase receipt, the complete set of RideSense, and the meter to any Giant dealer for inspection and warranty service.

Conditions that may void your product warranty:

- Modification of the product or its accessories.
- Using the product for purposes not intended for its design.
- Damages caused by failure to use this product according to instructions given in this manual.
- Additional costs derived from product failure.

Your warranty period or terms may vary with local regulations. The warranty provided does not affect your statutory rights under applicable legislation in force.

DGT statement

DO NOT change frequency, increase power, or modify design features and functions of low power radio transmitter and receiver with type qualification without approval in advance. Use of low power radio transmitter and receiver should not interfere with aviation safety and legitimate communications. In case of any interference, stop using the device immediately and resume its use only after the interference has been eliminated. The said legitimate communications is any radio communication operation approved by the telecommunication regulations. This device must accept any interference by legitimate communications or industrial, scientific, and medical radio equipment.

Troubleshooting

Please troubleshoot your product according to instructions given below. Please reset your RideSense afterwards. If the problem persists, call the dealer from whom you have purchased your product or contact Giant.

Symptom	Causes	Troubleshooting
ANT+ pairing failure	1. ANT+ device interference 2. Enter power saving and sleep mode	1. Make sure there is no active ANT transmitter in existence, e.g. speed/cadence device. Press and hold the RESET button for 12 seconds and wait for the red and green indicator to light up once respectively to reset your RideSense. 2. Move the cadence magnet or speed magnet across the RideSense to wake it up.
Bluetooth pairing failure	1. RideSense is Bluetooth connected 2. Enter power saving and sleep mode	1. Check whether the RideSense is busy when connected to other App/devices. If it remains busy, you may disconnect it by resetting your RideSense. Press and hold the RESET button for 12 seconds and wait for the red and green indicator to light up once respectively to reset your RideSense. 2. Move the cadence magnet or speed magnet across the RideSense to wake it up.
Connection to RideSense failure	1. Low battery power	Make sure there is adequate battery power left.
	2. Enter power saving and sleep mode	Move the cadence magnet or speed magnet across the RideSense to wake it up.
	3. Device pairing failed	Pair the devices.
Lack of speed or peddling frequency information	1. Poor magnet sensing	Make sure the magnet is installed within the sensing area.
	2. Enter power saving and sleep mode	Move the cadence magnet or speed magnet across the RideSense to wake it up.



Please recycle disposed batteries.

Mercury contents of this product comply with regulations 01890-AR4 of the EPA.

Note: Please remove the battery from your product if it will not be used for a long time. This will prevent the sensor from being damage by the leaking of battery electrolyte.

Precautions for RideSense product Use

Please read this manual carefully before using this RideSense product.

Please keep this manual in a safe and easy to access place for future reference.

Please consult an authorized GIANT dealer if you have any comments or questions about this manual.

- ❶ This product requires compatible Bluetooth 4.0 or later, GPS service, and OS on your smartphone for proper operation.
- ❷ In case of any product failure during its normal operation, try recovering it by powering your product off and on once or removing and re-inserting the battery before reinstalling this product.
- ❸ This product must be installed on a bike to function as designed.
- ❹ DO NOT modify, change, or disassemble the outer and inner structure, components, or power distribution system of this product.

Disclaimer:

- Giant and all its legal subsidiaries do not warrant or guarantee a rider or their property will be safer by using RideSense and its functions.
- Giant and all its legal subsidiaries shall fulfill its obligations according to service terms supplied with the product and provide these services to users based on reasonable technique and knowledge. In case of any of the conditions listed below, Giant may suspend, pause or terminate all or part of these services without any warning or compensation:
 1. Telecom operators failed to provide network services.
 2. Unexpected telecom equipment failures.
 3. Your service information displayed incorrectly or being forged, altered, deleted or retrieved due to factors not under control of this company.
 4. Interruption or termination of equipment or software services due to factors not attributable to Giant.
- Giant provides its product and services on the basis of "as is" and "as existing". Users shall be held liable for risks of invalid or incorrect operation of this service.
- Giant shall not assume any damage compensation liability or commit to or guarantee any compensation obligation caused by failure of this product in fulfilling specific functions which can be attributed to users' activities inconsistent with guideline or manual for this product.
- There are no express or implicit warranties or commitments, including but not limited to merchantability, fitness for particular purpose, and infringement of any right of any third party.