

|English|

GIANT

RECON PLUS TL150

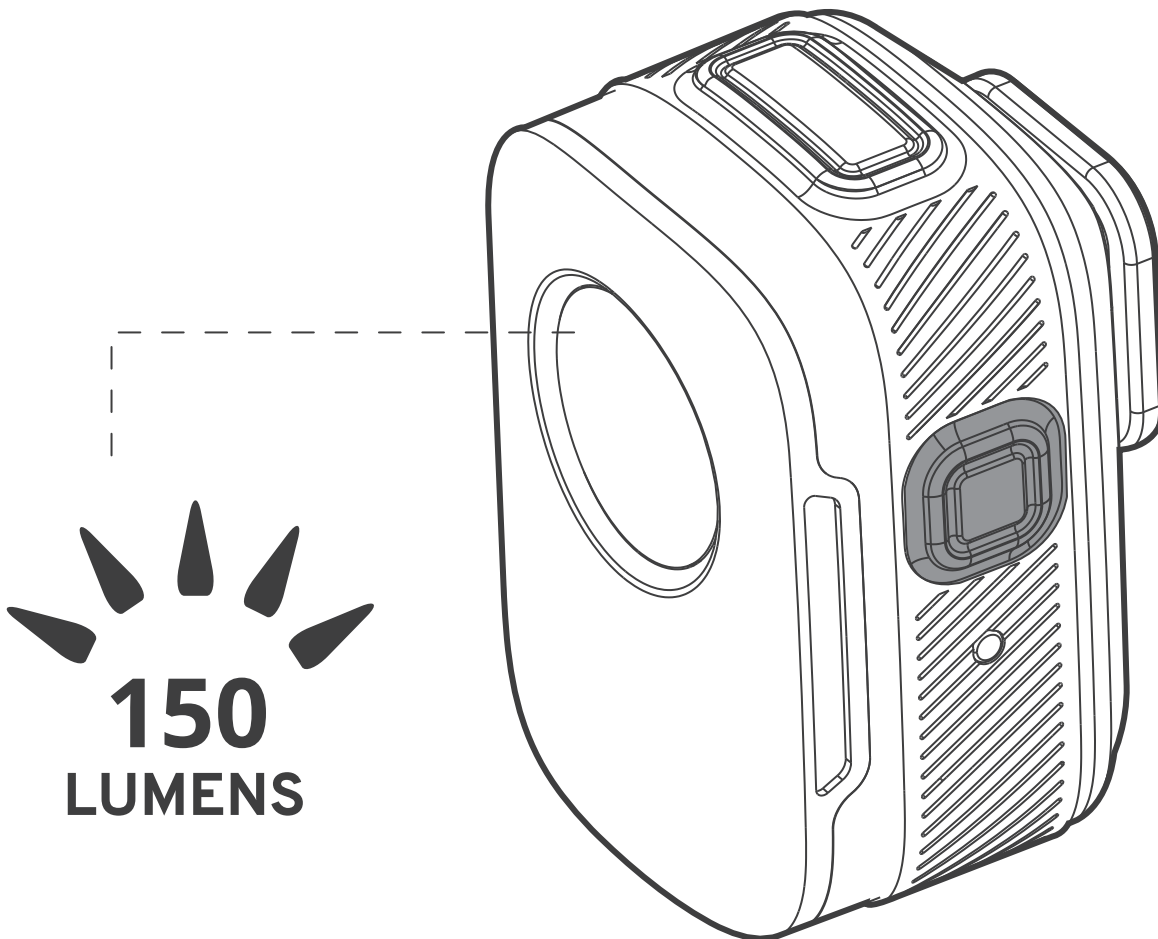

WARNING

- Do not look directly into the lights of other users, including those on other roads. This product emits an extremely powerful light beam that can cause eye damage and other injuries. Please use it with care.
- Please direct the light beam downward to avoid dazzling oncoming traffic and pedestrians.
- Do not use high beams in urban areas. Use high beams only on suburban roads and highways where there is little traffic.
- Before using this item, please ensure that the light has been securely mounted on the bracket, that the light can be turned on, and that the light will not be obstructed by luggage or items in the path of the beam.
- Keep this product away from children.
- Carry a spare light or battery pack with you, as the light may fail unexpectedly.
- This product is IPX6 rated in normal use and can therefore be used in the rain. This product, however, shall not be intentionally submerged in water.
- Charge the battery before use, please refer to "How to Charge" section for instructions.

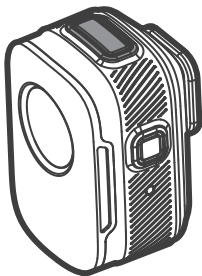

Light

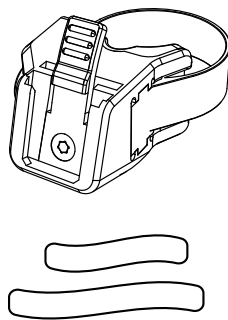

Mount

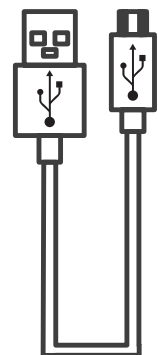
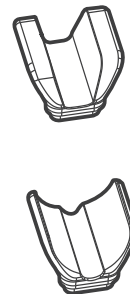
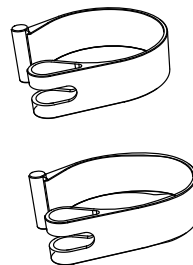

Type C

BIKE LIGHT OPERATION

POWER BUTTON

1. POWER ON/OFF:

Press and hold the power button for 1 second.

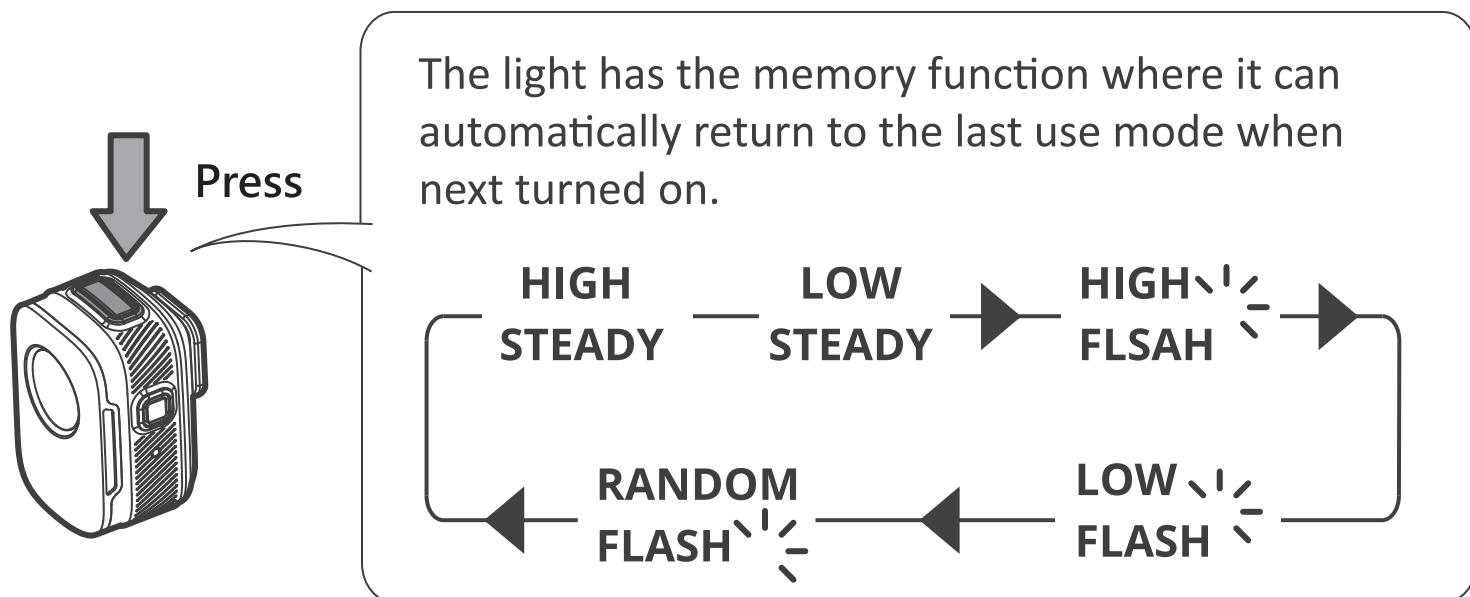

2. BATTERY INDICATOR:

Under the power-off state, click the power button once, the battery indicator will show the current battery level for 3 seconds before turning off. (See p.3 to learn battery indicator).

3. LOCK MODE:

When the device is in the power-off state, press and hold the power button for 5 seconds, the red battery indicator will quickly flash 3 times, to confirm that the device is locked. In lock mode, the power button and Bluetooth button will not work.

4. UNLOCK:

When the device is in lock mode, press and hold the power button for 5 seconds to unlock the device. The red battery indicator will quickly flash 3 times .

GROUP RIDING BUTTON

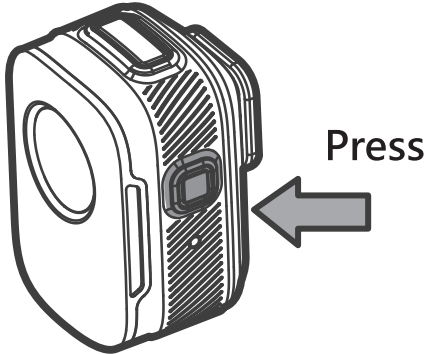

GROUP RIDING FUNCTION ON/OFF:

When the device is in the power-on state, press and hold the side button for 1 second; The Side indicator will be on and show Blue when the group riding function is enabled.

GROUP RIDING MODE:

When the group riding function is enabled, all Recon Plus TL300/ TL150 series will automatically enter group riding mode when they are within 20 meters of each other. The tail light will be on at a brightness of 5 lumens.

Pairing

CONNECT TO ANT+ DEVICE:

Shake the tail light to activate ANT+. Use the ANT+ device to search and pair the tail light. Once the device is connected, you can control the tail light and turn it on or off using the ANT+ device, then the purple light is always on.

RUNTIME

ANSI	HIGH	LOW	HIGH FLASH	LOW FLASH	RANDOM	GROUP RIDE
	70 LUMENS	20 LUMENS	150 LUMENS	15 LUMENS	20 LUMENS	5 LUMENS
	2.5 hr	8 hr	7 hr	35 hr	30 hr	25 hr

BATTERY INDICATOR

Constant green: 100%-70%

Constant yellow: 70%-40%

Constant red: 40%-10%

Flashing red indicates 10%-1% The device is entering low power mode (5LM low flash).

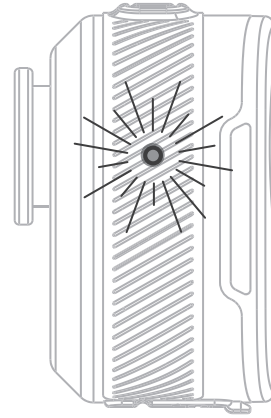

How to charge

 Please charge before use.

USB C

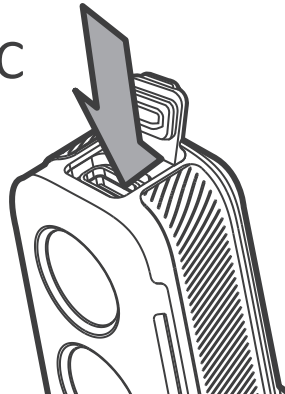

Approx. 2hrs(0.6A)

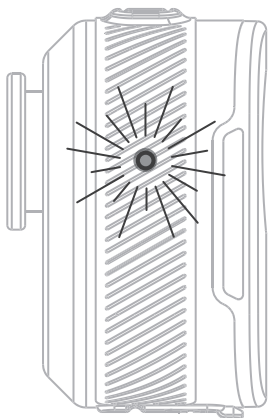

**Flashing
green light**

Charging

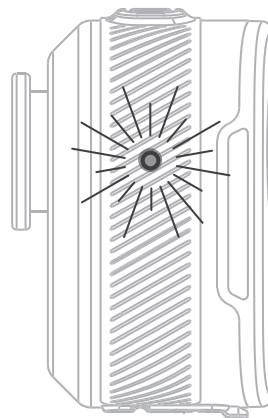

**Constant
green light**

Charging complete

INSTALLATION

1.

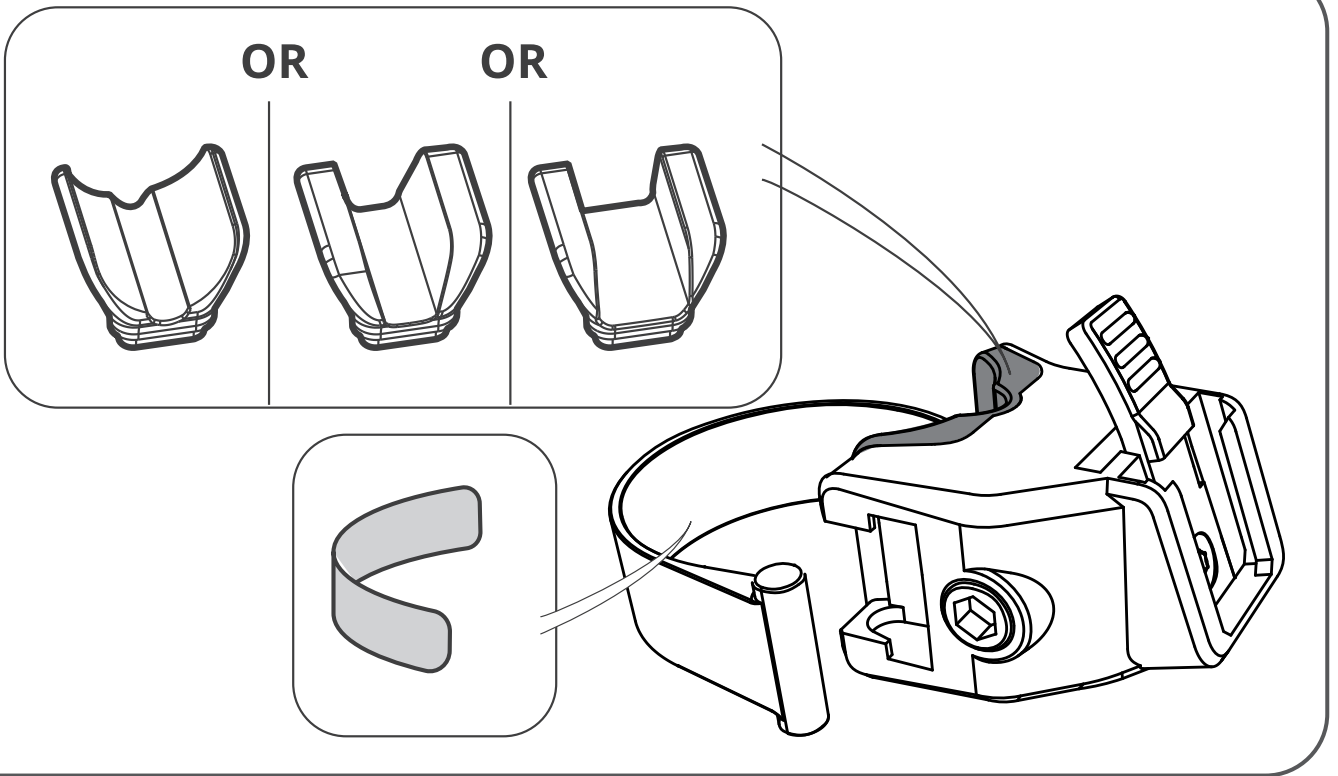

2.

